

2/24/2025

WATER WORKS BRASS CORPORATION STOPS

www.jabosupply.com



**CAMBRIDGE
BRASS**™
INC

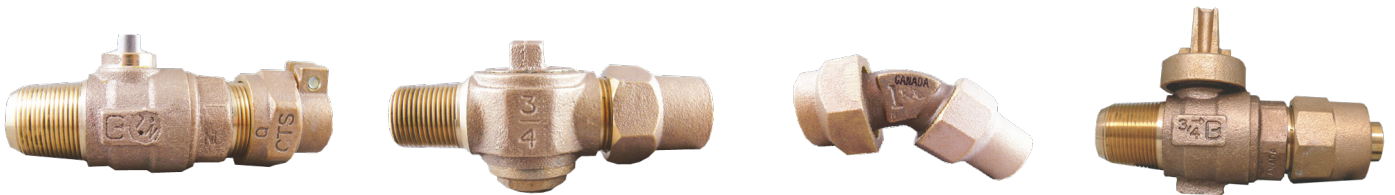

CORPORATION STOPS



INDEX











CORPORATION STOPS

DESCRIPTIONS	PAGE #
PICTURE INDEX PAGES 3-4	
<i>IDENTIFYING the DIFFERENT CORP STOPS</i>	3-4
PLUG CORP 100 PSI PAGES 5-9	
<i>AWWA X CAMPAK (CTS)</i>	6
<i>MIP X CAMPAK (CTS)</i>	6
<i>AWWA X GRIP JOINT (CTS)</i>	6
<i>MIP X GRIP JOINT (CTS)</i>	6
<i>AWWA X CB COMPRESSION (CTS)</i>	7
<i>MIP X CB COMPRESSION</i>	7
<i>AWWA X PEP SIDR 7 (IPS)</i>	7
<i>MIP XPEP SIDR 7 (IPS)</i>	7
<i>AWWA X PVC COMPRESSION (IPS)</i>	8
<i>MIP X PVC COMPRESSION (IPS)</i>	8
<i>MIP X FIP</i>	8
<i>MIP X MIP</i>	8
<i>AWWK X FIP</i>	9
<i>AWWA X MIP</i>	9
BALL CORP 300 PSI PAGES 10-14	
<i>AWWK X CAMPAK (CTS)</i>	11
<i>MIP X CAMPAK (CTS)</i>	11
<i>AWWA X GRIP JOINT CTS</i>	11
<i>MIP X GRIP JOINT (CTS)</i>	11
<i>AWWA X CB COMPRESSION (CTS)</i>	12
<i>MIP X CB COMPRESSION (CTS)</i>	12
<i>AWWA X PEP SIDR 7 (IPS)</i>	12
<i>MIP X PEP SIDR 7 IPS</i>	12
<i>AWWA X PVC (IPS)</i>	13
<i>MIP X PVC IPS</i>	13
<i>MIP X FIP</i>	13
<i>MIP X MIP</i>	13
<i>AWWA X FIP</i>	14
<i>AWWA X MIP</i>	14

PICTURE INDEX

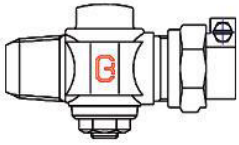
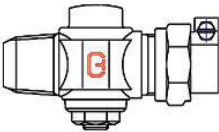
CORP STOPS

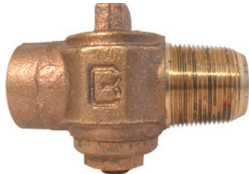

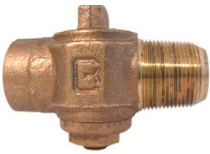
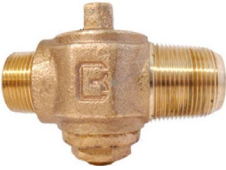









PLUG 100 PSI PAGES 5-9

PLUG CORP 100 PSI <i>AWWA X CAMPAK (CTS)</i>	PLUG CORP 100 PSI <i>MIP X CAMPAK (CTS)</i>	PLUG CORP 100 PSI <i>AWWA X GRIP JOINT (CTS)</i>	PLUG CORP 100 PSI <i>MIP X GRIP JOINT (CTS)</i>
			
PAGE 6	PAGE 6	PAGE 6	PAGE 6
PLUG CORP 100 PSI <i>AWWA X CB COMPRESSION (CTS)</i>	PLUG CORP 100 PSI <i>MIP X CB COMPRESSION</i>	PLUG CORP 100 PSI <i>AWWA X PEP SIDR 7 (IPS)</i>	PLUG CORP 100 PSI <i>MIP X PEP SIDR 7 (IPS)</i>
			
PAGE 7	PAGE 7	PAGE 7	PAGE 7
PLUG CORP 100 PSI <i>AWWA X PVC COMPRESSION (IPS)</i>	PLUG CORP 100 PSI <i>MIP X PVC COMPRESSION (IPS)</i>	PLUG CORP 100 PSI <i>MIP X FIP</i>	PLUG CORP 100 PSI <i>MIP X MIP</i>
			
PAGE 8	PAGE 8	PAGE 8	PAGE 8
PLUG CORP 100 PSI <i>AWWK X FIP</i>	PLUG CORP 100 PSI <i>AWWA X MIP</i>		
			
PAGE 9	PAGE 9		

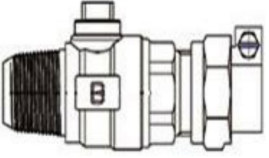
PICTURE INDEX

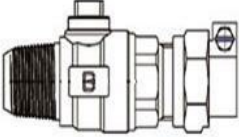
CORP STOPS

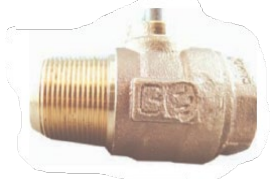
BALL 300 PSI PAGE 10-14

BALL CORP 300 PSI	BALL CORP 300 PSI	BALL CORP 300 PSI	BALL CORP 300 PSI
<i>AWWK X CAMPAK (CTS)</i>	<i>MIP X CAMPAK (CTS)</i>	<i>AWWA X GRIP JOINT CTS</i>	<i>MIP X GRIP JOINT (CTS)</i>
			
PAGE 11	PAGE 11	PAGE 11	PAGE 11
BALL CORP 300 PSI	BALL CORP 300 PSI	BALL CORP 300 PSI	BALL CORP 300 PSI
<i>AWWA X CB COMPRESSION (CTS)</i>	<i>MIP X CB COMPRESSION (CTS)</i>	<i>AWWA X PEP SIDR 7 (IPS)</i>	<i>MIP X PEP SIDR 7 IPS</i>
			
PAGE 12	PAGE 12	PAGE 12	PAGE 12
BALL CORP 300 PSI	BALL CORP 300 PSI	BALL CORP 300 PSI	BALL CORP 300 PSI
<i>AWWA X PVC (IPS)</i>	<i>MIP X PVC IPS</i>	<i>MIP X FIP</i>	<i>MIP X MIP</i>
			
PAGE 13	PAGE 13	PAGE 13	PAGE 13
BALL CORP 300 PSI	BALL CORP 300 PSI		
<i>AWWA X FIP</i>	<i>AWWA X MIP</i>		
			
PAGE 14	PAGE 14		

PLUG CORPORATION STOPS

Plug Valve Corporation Stops are precision machined to assure a perfect match between the plug and the body. The same machining precision carries over the threads to assure Cambridge Brass high quality. Corporation Stops come standard with a 360 degree operating head. Use only smooth jawed wrenches on the corporation stop bodies and position the wrench only on the flats provided on the bodies. Also position your wrench as close as possible to the threads being tightened to avoid excessive strain or bending moment on the body. Pressure ratings are 100 PSIG for 3/4" and 1" For applications over 1" Cambridge Brass recommends the use of Ball Valves .

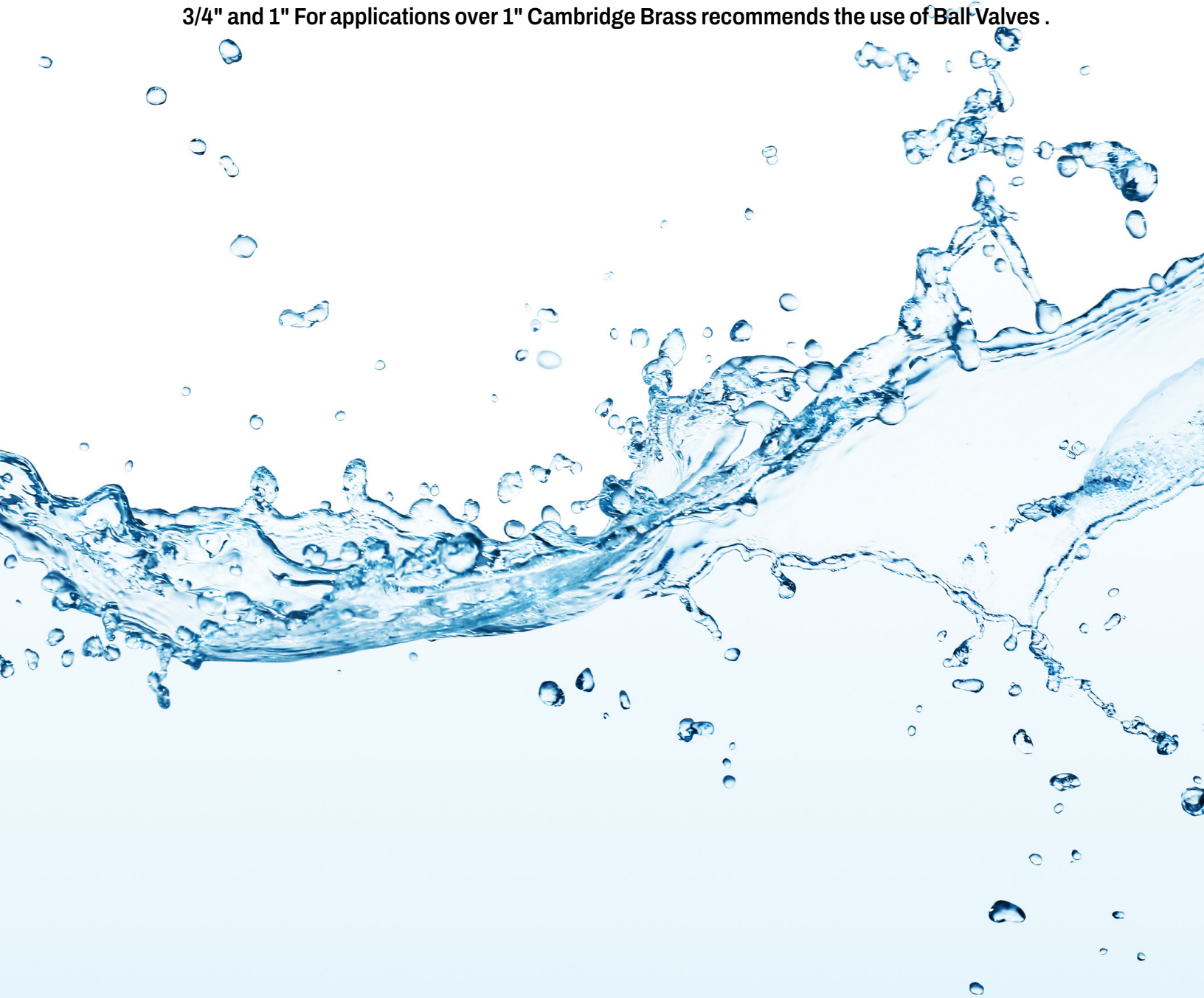

CORPORATION STOPS

PLUG 302NL

PLUG CORP

AWWA ((aka Tapered or CC) X CAMPAK
100 PSI



Jabo #	MFG #	Inlet	Outlet
031-16196	302NL-A3B3	3/4"	3/4"
031-16200	302NL-A3B4	3/4"	1"
031-16264	302NL-A4B4	1"	1"

*NON STOCK CALL JABO SUPPLY

PLUG CORP

MIP (aka Straight) X CAMPAK
100 PSI



Jabo #	MFG #	Inlet	Outlet
031-16312	302NL-M3B3	3/4"	3/4"
*	302NL-M3B4	3/4"	1"
031-16348	302NL-M4B4	1"	1"

*NON STOCK CALL JABO SUPPLY

PLUG CORP

AWWA ((aka Tapered or CC) X GRIP JOINT
100 PSI



Jabo #	MFG #	Inlet	Outlet
031-16216	302NL-A3GJ3	3/4"	3/4"
*	302NL-A3GJ4	3/4"	1"
031-16280	302NL-A4GJ4	1"	1"

*NON STOCK CALL JABO SUPPLY

PLUG CORP

MIP (aka Straight) X GRIP JOINT
100 PSI



Jabo #	MFG #	Inlet	Outlet
*	302NL-M3GJ3	3/4"	3/4"
*	302NL-M3GJ4	3/4"	1"
*	302NL-M4GJ4	1"	1"

*NON STOCK CALL JABO SUPPLY

CORPORATION STOPS

PLUG 302NL

PLUG CORP

AWWA ((aka Tapered or CC) X CB COMPRESSION
100 PSI

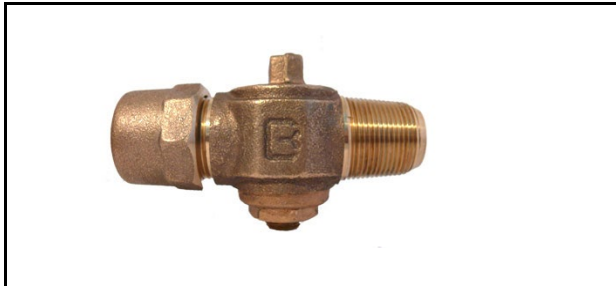

Jabo #	MFG #	Inlet	Outlet
031-16220	302NL-A3H3	3/4"	3/4"
031-16224	302NL-A3H4	3/4"	1"
031-16284	302NL-A4H4	1"	1"

*NON STOCK CALL JABO SUPPLY

PLUG CORP

MIP ((aka Straight) X CB COMPRESSION
100 PSI



Jabo #	MFG #	Inlet	Outlet
031-16328	302NL-M3H3	3/4"	3/4"
*	302NL-M3H4	3/4"	1"
031-16360	302NL-M4H4	1"	1"

*NON STOCK CALL JABO SUPPLY

PLUG CORP

AWWA X PEP COMPRESSION (PEP SIDR7)
100 PSI

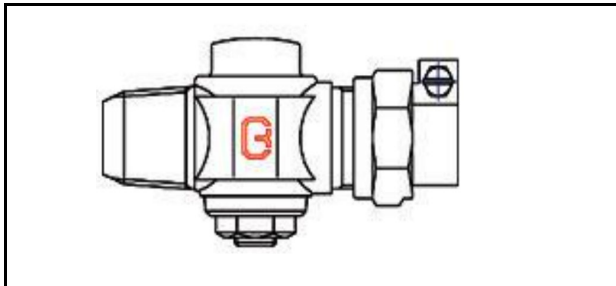

Jabo #	MFG #	INLET	OUTLET
031-16256	302NL-A3PE3	3/4"	3/4"

*NON STOCK CALL JABO SUPPLY

CORP STOP- PLUG

MIP ((aka Straight) X PEP SIDR 7
100 PSI

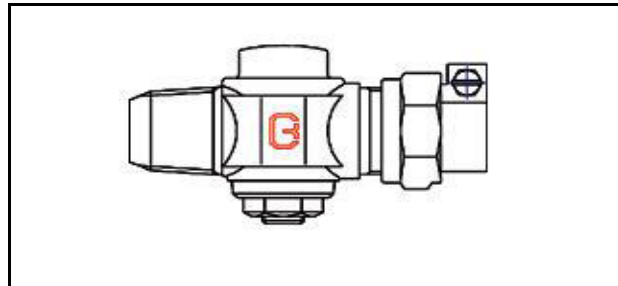

Jabo #	MFG #	Inlet	Outlet
*	302NL-M3PE3	3/4"	3/4"

*NON STOCK CALL JABO SUPPLY

CORPORATION STOPS

PLUG 302NL

CORP STOP- PLUG

AWWA ((aka Tapered or CC) X PVC Compression (IPS)

100 PSI

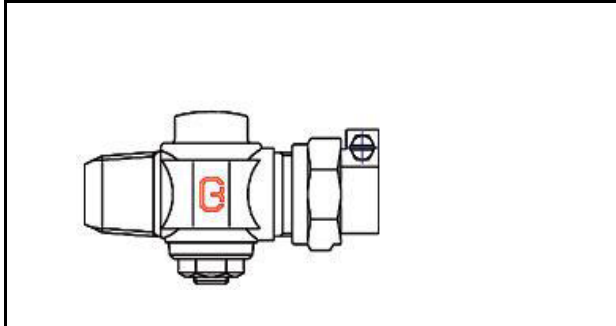

Jabo #	MFG #	Inlet	Outlet
*	302NL-A3PJ3	3/4"	3/4"

*NON STOCK CALL JABO SUPPLY

CORP STOP- PLUG

MIP ((aka Straight) X PVC Compression (IPS)

100 PSI

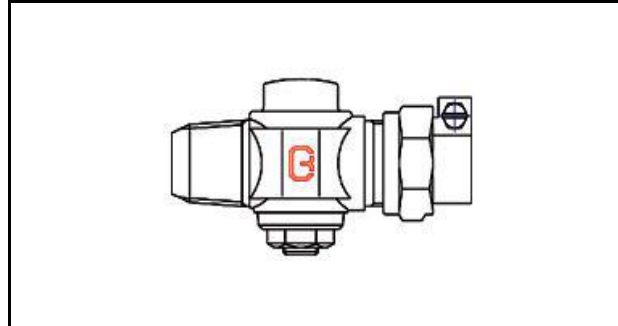

Jabo #	MFG #	Inlet	Outlet
*	302NL-M3PJ3	3/4"	3/4"

*NON STOCK CALL JABO SUPPLY

PLUG CORP

MIP ((aka Straight) X FIP

100 PSI

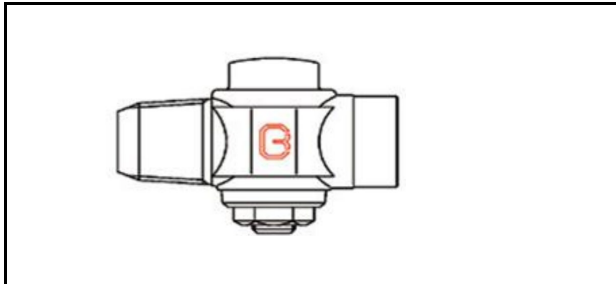

Jabo #	MFG #	Inlet	Outlet
*	302NL-M1F1	1/2"	1/2"
*	302NL-M3F3	3/4"	3/4"
*	302NL-M4F4	1"	1"

*NON STOCK CALL JABO SUPPLY

PLUG CORP

MIP ((aka Straight) X MIP

100 PSI



Jabo #	MFG #	Inlet	Outlet
*	302NL-M3M3	3/4"	3/4"
*	302NL-M4M4	1"	1"

*NON STOCK CALL JABO SUPPLY

CORPORATION STOPS

PLUG 302NL

PLUG CORP

AWWA (aka Tappered or CC)X FIP
100 PSI



Jabo #	MFG #	Inlet	Outlet
*	302NL-A3F3	3/4"	3/4"
*	302NL-A4F4	1"	1"

*NON STOCK CALL JABO SUPPLY

PLUG CORP

AWWA (aka Tappered or CC)X MIP
100 PSI



Jabo #	MFG #	Inlet	Outlet
*	302NL-A3M3	3/4"	3/4"
*	302NL-A4M4	1"	1"

BALL CORPORATION STOPS

Ball Valve Corporation Stops come standard with 360 degree operating head and are designed for low turning torques and high pressures (300) psig. The no-lead brass ball is supported by two PTFE ball seats. Additionally there are two Buna-N orings on the Stainless Steel blow out proof stem designed to isolate from line pressure. The end piece joint is permanently sealed with thread locker. The bubble tight feature at 300 PSIG makes these valves a better choice than a plug valve when tested or operating pressures over 100 PSIG are expected. All Cambridge Brass Ball Valve Corporation Stops are available with a wide variety of end connections and are manufactured to meet or exceed AWWA C800 (latest version) and NSF 61 & 372 standards, except where noted on manufacture catalog

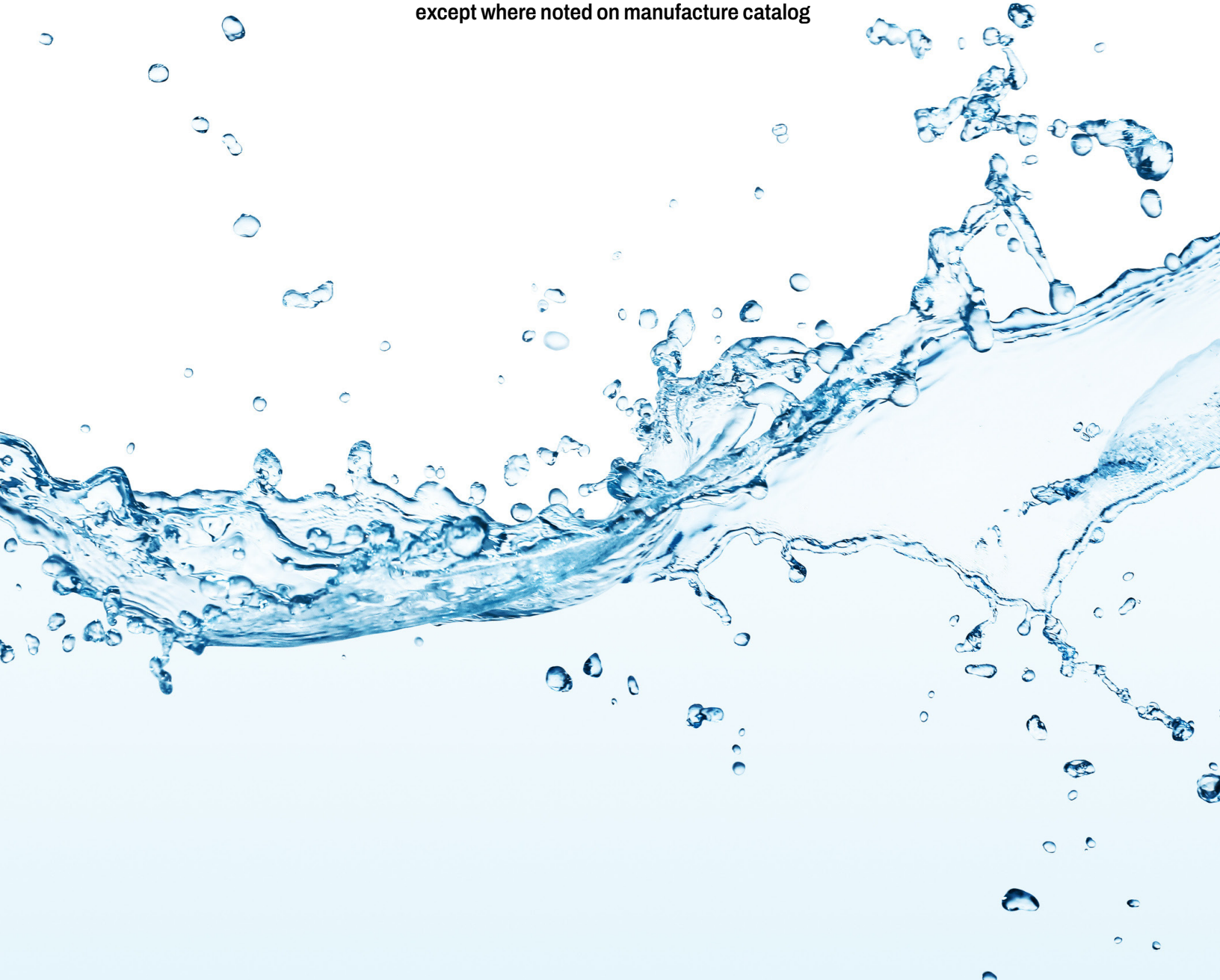

CORPORATION STOPS

BALL CORP 301NL

BALL CORP

AWWA/CC (aka Tapered or CC) X CAMPAK
300 PSI



Jabo #	MFG #	Inlet	Outlet
031-15676	301NL-A3B3	3/4"	3/4"
031-15744	301NL-A4B4	1"	1"
*	301NL-A5B5	1-1/4"	1-1/4"
*	301NL-A6B6	1-1/2"	1-1/2"
*	301NL-A6B7	1-1/2"	2"
031-15904	301NL-A7B7	2"	2"

*NON STOCK CALL JABO SUPPLY

BALL CORP

MIP (aka Straight)X CAMPAK
300 PSI



Jabo #	MFG #	Inlet	Outlet
031-15968	301NL-M3B3	3/4"	3/4"
031-16020	301NL-M4B4	1"	1"
*	301NL-M5B5	1-1/4"	1-1/4"
*	301NL-M6B6	1-1/2"	1-1/2"
*	301NL-M6B7	1-1/2"	2"
031-16144	301NL-M7B7	2"	2"

*NON STOCK CALL JABO SUPPLY

BALL CORP

AWWA/CC ((aka Tapered or CC) X GRIP JOINT
300 PSI



Jabo #	MFG #	Inlet	Outlet
031-15688	301NL-A3GJ3	3/4"	3/4"
031-15760	301NL-A4GJ4	1"	1"

BALL CORP

MIP (aka Straight)X GRIPJOINT
300 PSI

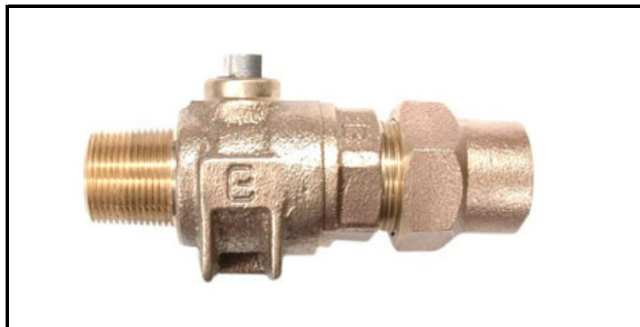

Jabo #	MFG #	Inlet	Outlet
*	301NL-M3GJ3	3/4"	3/4"
*	301NL-M3GJ4	3/4"	1"
*	301NL-M4GJ4	1"	1"
*	301NL-M6GJ6	1-1/2"	1-1/2"
*	301NL-M7GJ7	2"	2"

*NON STOCK CALL JABO SUPPLY

CORPORATION STOPS

BALL CORP 301NL

BALL CORP

AWWA/CC (Tapered or CC) x CB COMPRESSION
300 PSI



Jabo #	MFG #	Inlet	Outlet
*	301NL-A1H1	1/2"	1/2"
*	301NL-A1H2	1/2"	5/8"
*	301NL-A2H2	5/8"	5/8"
031-15692	301NL-A3H3	3/4"	3/4"
*	301NL-A3H4	3/4"	1"
031-15764	301NL-A4H4	1"	1"
*	301NL-A5H5	1-1/4"	1-1/4"
*	301NL-A6H6	1-1/2"	1-1/2"
*	301NL-A6H7	1-1/2"	2"
*	301NL-A6H7	2"	2"

*NON STOCK CALL JABO SUPPLY

BALL CORP

MIP (aka Straight) X CB COMPRESSION
300 PSI

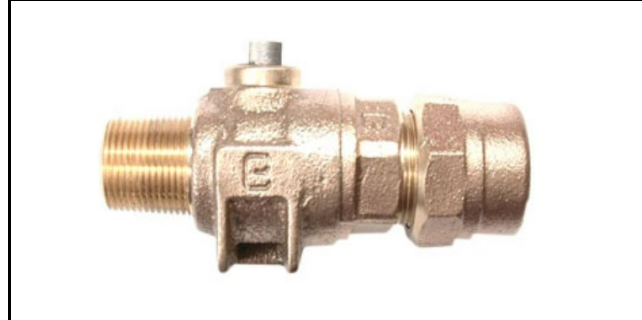

Jabo #	MFG #	Inlet	Outlet
031-15988	301NL-M3H3	3/4"	3/4"
031-16036	301NL-M4H4	1"	1"
*	301NL-M5H5	1-1/4"	1-1/4"
*	301NL-M6H6	1-1/2"	1-1/2"
*	301NL-M6H7	1-1/2"	2"
031-16160	301NL-M7H7	2"	2"

*NON STOCK CALL JABO SUPPLY

BALL CORP

AWWA(aka: Tapered or CC) PEP (SIDR7)
300 PSI



Jabo #	MFG #	Inlet	Outlet
031-15736	301NL-A3PE3	3/4"	3/4"
031-15804	301NL-A4PE4	1"	1"
*	301NL-A5PE5	1-1/4"	1-1/4"
*	301NL-A6PE6	1-1/2"	1-1/2"
*	301NL-A7PE7	2"	2"

*NON STOCK CALL JABO SUPPLY

BALL CORP

MIP X-PEP (SIDR7)
300 PSI

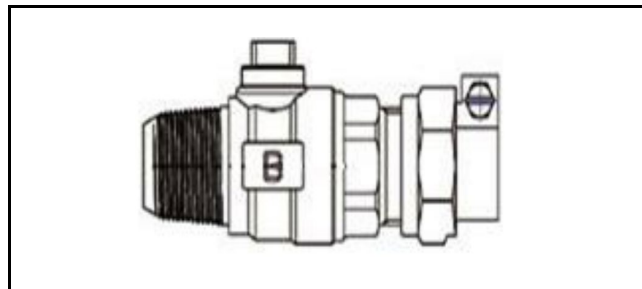

Jabo #	MFG #	Inlet	Outlet
*	301NL-M3PE3	3/4"	3/4"
*	301NL-M4PE4	1"	1"
*	301NL-M5PE5	1-1/4"	1-1/4"
*	301NL-M6PE6	1-1/2"	1-1/2"
*	301NL-M7PE7	2"	2"

*NON STOCK CALL JABO SUPPLY

CORPORATION STOPS

BALL CORP 301NL

BALL CORP

AWWA (Tapered or CC) X PVC COMPRESSION (IPS)
300 PSI



Jabo #	MFG #	Inlet	Outlet
*	301NL-A3PJ3	3/4"	3/4"
*	301NL-A4PJ4	1"	1"
*	301NL-A5PJ5	1-1/4"	1-1/4"
*	301NL-A6PJ6	1-1/2"	1-1/2"
*	301NL-A7PJ7	2"	2"

*NON STOCK CALL JABO SUPPLY

BALL CORP

MIP (STRAIGHT) X PVC COMPRESSION (IPS)
300 PSI

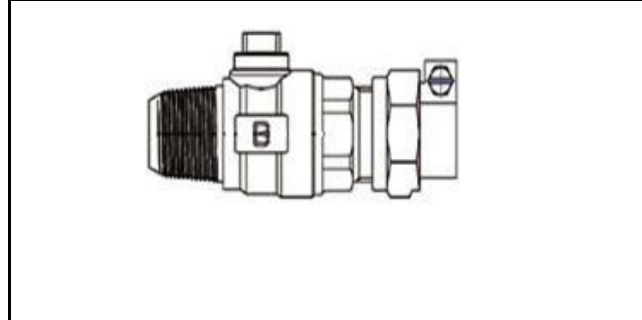

Jabo #	MFG #	Inlet	Outlet
*	301NL-M3PJ3	3/4"	3/4"
*	301NL-M4PJ4	1"	1"
*	301NL-M5PJ5	1-1/4"	1-1/4"
*	301NL-M6PJ6	1-1/2"	1-1/2"
031-16180	301NL-M7PJ7	2"	2"

*NON STOCK CALL JABO SUPPLY

BALL CORP

MIP ((aka Straight) X FIP)
300 PSI



Jabo #	MFG #	Inlet	Outlet
*	301NL-M3F3	3/4"	3/4"
031-16028	301NL-M4F4	1"	1"
*	301NL-M5F5	1-1/4"	1-1/4"
*	301NL-M5F6	1-1/2"	1-1/2"
*	301NL-M6F6	1-1/2"	1-1/2"
031-16152	301NL-M7F7	2"	2"

*NON STOCK CALL JABO SUPPLY

BALL CORP

MIP ((aka Straight) X MIP)
300 PSI



Jabo #	MFG #	Inlet	Outlet
*	301NL-M3M3	3/4"	3/4"
*	301NL-M4M4	1"	1"
*	301NL-M5M5	1-1/4"	1-1/4"
*	301NL-M6M6	1-1/2"	1-1/2"
*	301NL-M6M7	1-1/2"	2"
031-16172	301NL-M7M7	2"	2"

*NON STOCK CALL JABO SUPPLY

CORPORATION STOPS

BALL CORP 301NL

BALL CORP

AWWA (aka Tapered or CC)X FIP

300 PSI

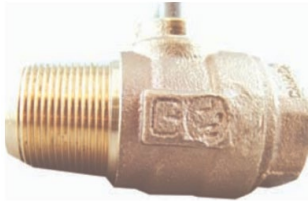

Jabo #	MFG #	Inlet	Outlet
*	301NL-A3F3	3/4"	3/4"
*	301NL-A4F4	1"	1"
*	301NL-A5F5	1-1/4"	1-1/4"
*	301NL-A6F6	1-1/2"	1-1/2"
031-15916	301NL-A7F7	2"	2'

*NON STOCK CALL JABO SUPPLY

BALL CORP

AWWA (aka Tapered or CC)X MIP

300 PSI



Jabo #	MFG #	Inlet	Outlet
*	301NL-A1M1	1/2"	1/2"
*	301NL-A3M3	3/4"	3/4"
*	301NL-A4M4	1"	1"
*	301NL-A5M5	1-1/4"	1-1/4"
*	301NL-A5M6	1-1/4"	1-1/2"
*	301NL-A6M6	1-1/2"	1-1/2"
*	301NL-A6M7	1-1/2"	2"
031-15940	301NL-A7M7	2"	2"

*NON STOCK CALL JABO SUPPLY

NOTES



JABO SUPPLY

JABO LOCATIONS

HUNTINGTON, WV

209 Braley Street, 25705
(304) 736-8333

PARKERSBURG, WV

10085 Emerson Avenue 26102
(304) 464-4400

NORTON, VA

205 Hawthorne Drive, 24273
(276) 679-1224

MORGANFIELD, KY

118 Jim Veatch Road, 42437
(270) 389-3430

BEAVER, WV (BECKLEY)

227 C&O Shop Road 25813
(304)-252-0000

SINCE 1964 SERVICE IS MORE THAN A PROMISE